

**moveero**

evolving every day



Revolutionizing the way  
you think about wheels

# Revolutionizing the agricultural wheel

**Providing easier fitting of low pressure tires, combined with high strength and no loss of performance, it is clear to see why the patented 'Profi' range of solutions has become an industry favorite.**

Designed and tested by a global team of moveero engineers, we provide solutions that relate to real-life problems in the field. The world of agriculture is becoming ever more demanding with the need for efficiency and durability; providing solutions that add value and bring benefits to both the Original Equipment Manufacturer and end user – is what we offer with our Profi-range of products.

- Globally available and designed to ETRTO standards.
- TW profile specially angled section, more than double the ETRTO minimum of 15°.
- Evolution of design, tried and tested in house with thousands in use globally.

moveero has been designing, manufacturing and supplying wheels since 1908 and with our extensive product research, design and development capabilities, we are committed to continuous improvement and the delivery of innovative solutions.

Working closely with our OE and tire partners, our research and design teams are at the forefront of developing products that enhance performance for a variety of agricultural wheeled applications.

## Industry leading – evolving every day

Leading the industry with our approach to the design, test and manufacture of wheels, we rigorously test and validate all new design and product enhancements. As one of the few organizations with the total engineering capability to offer design, simulation and validation we continue to make significant investments in both laboratory and field testing equipment to enable us to stay at the forefront of industry pain points and trends.

Continuous investment across our facilities, including production, processes, R&D and test equipment, reinforces our commitment to leading the industry in engineering and design excellence and continuing to provide outstanding products and services.

# Patented Design

## TW Profile gives tire protection

- TW Profile gives tire protection
- Enables easier tire seating.
- Are 25% quicker to mount – improving efficiency.
- With 30% less inflation pressure required – improving safety.
- Lighter weight.



Rolled over flange improves rim strength and initial fitting of tire. Improves performance with low pressure tires.

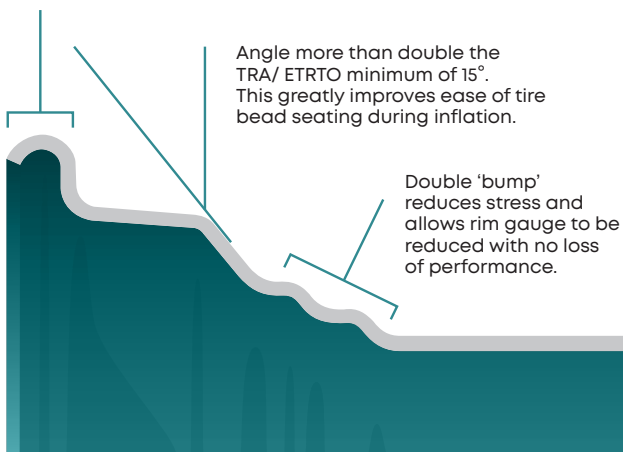

**New Profile – 4.7mm thick**

Ultimate fatigue failure normally occurs in these radii. This determines minimum rim thickness. The changes to the rim profile reduce the stresses here.

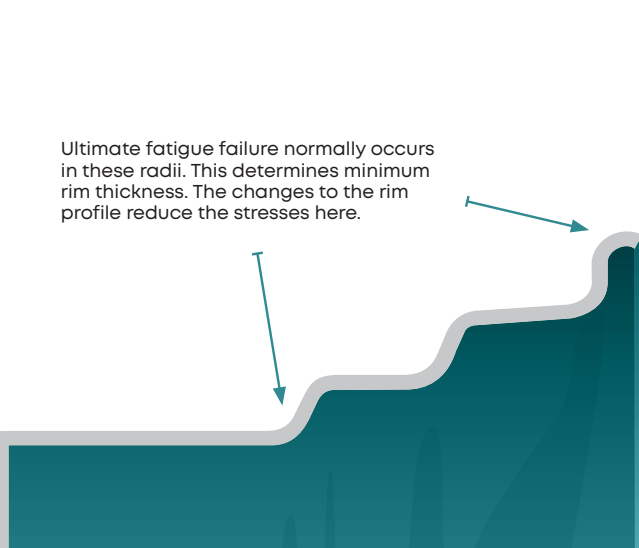

**Standard DW – 5.2mm thick**

- Lower stress on rim well radii thanks to geometry.
- Higher material thickness in well radii thanks to easier forming (less thinning during rim rolling) – on top of geometrical stress reduction.

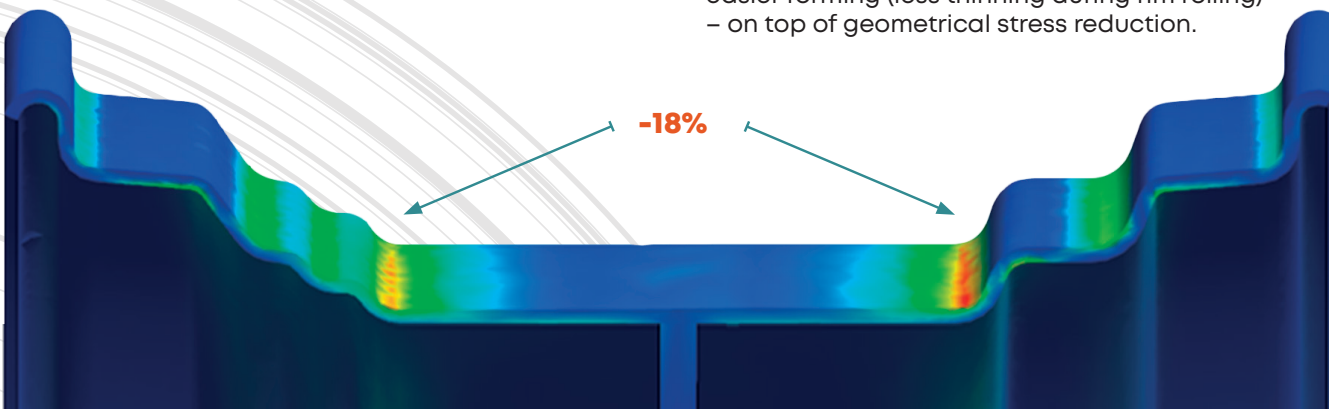

# Profi-Fit

moveero

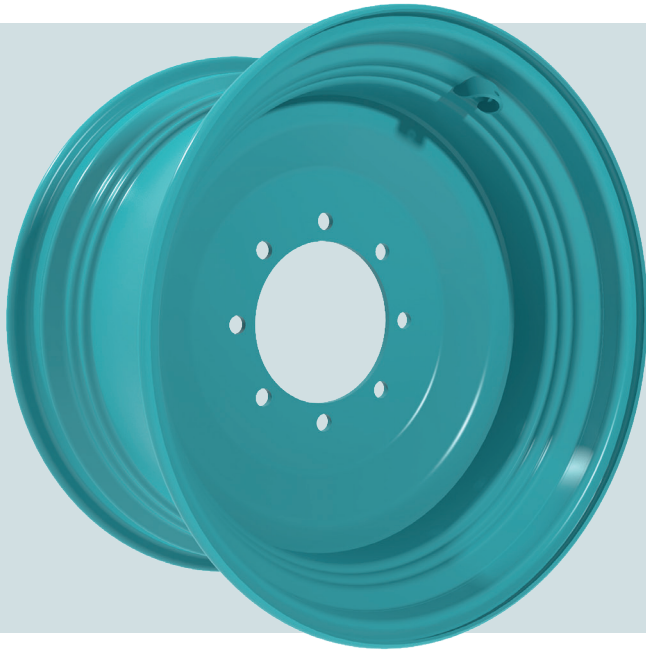
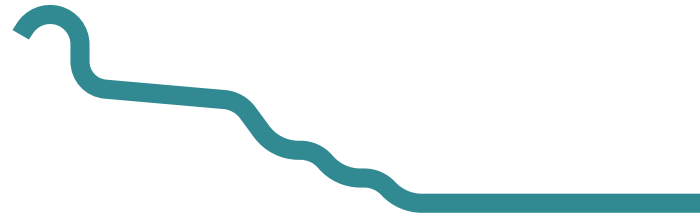

## Easier tire fitting

- The perfect solution for low-pressure agricultural tire applications.
- Weight optimization and durability minimizes the risk of soil compaction.
- Improved rim strength ensures easy tire fitting.
- Designed to control runout.

Designed by our global team of moveero engineers, the Profi-Fit wheel combines durability with reduced weight and easier tire fitting, bringing benefits to both original equipment manufacturers and end users.

Our patented Profi-Fit wheel is the perfect solution for low-pressure agricultural tire applications, combining durability with reduced weight and easier tire fitting. Used extensively to minimize the risk of soil compaction, low-pressure tires typically have stiffer walls, making them more difficult to fit. However, Profi-Fit was specifically designed to address this problem, with its rolled-over flange improving rim strength and minimizing the risk of tire damage during installation.

First introduced to the market in 2009, the triple well Profi-Fit Wheel.

- Eliminates problems with mounting of stiff tires for high loading capacity.
- Allows for faster tire mounting.
- Designed for use with low pressure during tire inflation which increases safety.
- Reduced weight.
- Rollover flange improves strength and minimizes tire damage during fitting.

The unique angled section, more than double the ETRTO minimum of 15 degrees, greatly improves the ease of tire bead seating during inflation and allows tires to be fitted to pressures below 2 bar.

The wheel incorporates a unique 'double bump' radius design at a critical point where traditional rims are susceptible to ultimate fatigue failure reducing stress, whilst maintaining strength and performance. The lower wheel weight in turn, reduces vehicle group pressure and contributes to savings in fuel consumption and carbon emissions.

Typical applications for a Profi-Fit rim include combines, self-propelled forage harvesters and tractors.



# Profi-Grip

moveero

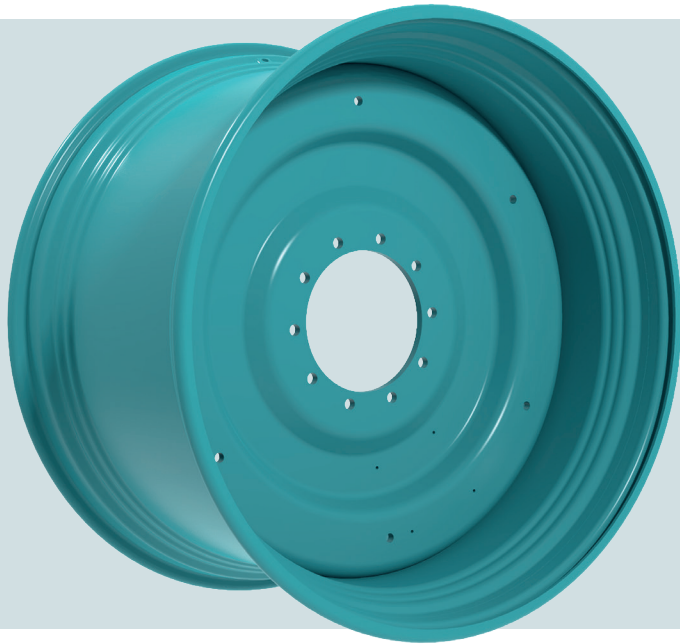
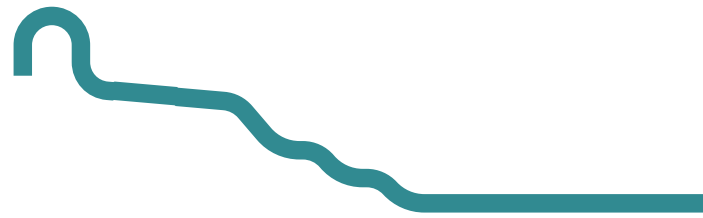

## Eliminating tire slippage

- Innovative design solution.
- Eliminates the risk of tire slippage.
- Easier fitting of high load capacity tires.
- Enhanced durability.
- Strong flange design minimizes rim shrinkage and protects the tire when used at low pressure.
- Improved contact pressure between the tire and rim.
- Reduced weight.
- Profi-Grip utilizes the patented Profi-Fit (TW) rim profile.
- Which, allows faster tire mounting for increased efficiency.
- Allows use of low pressure during tire inflation which increases safety.

Tire slippage has become increasingly problematic over recent years. The combination of larger tractors, increased horsepower, larger implement machinery, low inflation pressure with Central Tire Inflation systems (CTIS), and heavy loads is causing tire slippage.

Tire manufacturers are developing tires to run at a low inflation pressure to maximize the 'footprint' and the transfer of power from the tractor to the soil.

The moveero Profi-Grip feature a unique profile, developed to eliminate tire-to-rim slippage. Featuring a strong flange which both minimizes rim shrinkage, and serves to protect the tire when used at low pressure, the Profi-Grip wheel also incorporates our patented Profi-Fit TW design, which allows high-load capacity tires, with very stiff side walls, to be mounted easily and with no risk of tire damage.

- Improved contact pressure between tire and rim.
- Prevents tire slippage and damage.
- Ideal for IF and VF low pressure tires.
- Improved flange design improves rim stiffness and enhances durability.
- Incorporates Profi-Fit TW profile.
- In 2018 the range was extended to include 44" profiles.

Designed to ETRTO standards and launched to meet the growing demand from ever-larger and more-powerful tractors, the Profi-Grip wheel has been developed to deliver significantly improved contact pressure between the tire and rim – which not only eliminates slippage but also makes the fitting of high-load capacity tires faster and safer, it also provides enhanced durability.

Profi-Grip delivers benefits in wet conditions during the winter, but equally has proved its value during the dry conditions of the summer months experienced in some regions – where the issues of traction and tire slippage are equally problematic.



# Profi-Flex<sup>HS</sup>

moveero



## Track adjustment to optimize yield and comfort at high speeds

- Continuously welded flange ring joins the bolted center disc to the wheel rim.
- Increased bolt stretch.
- 16 offset positions, 15mm between each.
- Can operate at speeds of up to 50km/h and available with moveero's patented TW Profi-Fit rim profile.
- Standard wheel designs allows up to as much as 260HP.
- Rack position moves to optimize the greatest yield on crops.
- High performance life and low fatigue due to structurally efficient joint structure.

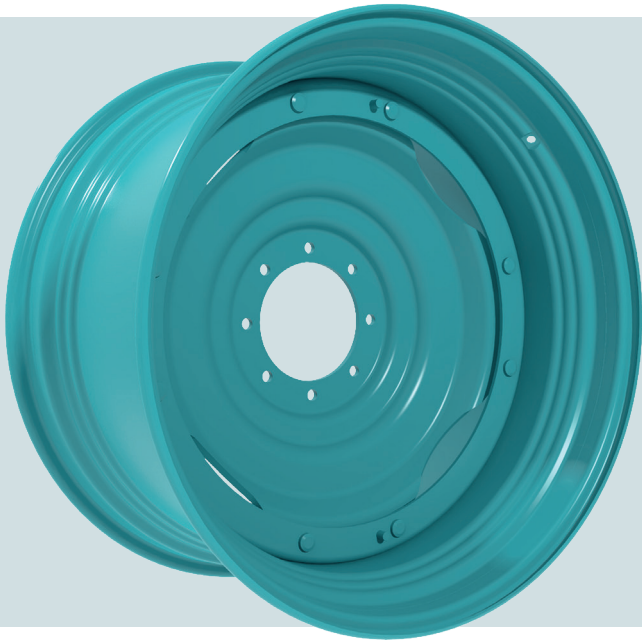

The Profi-Flex wheel is moveero manually adjustable variable track wheel and a well-proven industry standard. The Profi-Flex wheel features 16 different track positions, with 15mm between, resulting in accurate and precise positioning when planting varying crops or moving from field to field.

The variable width also lends itself to situations where more steering ability or traction may be required.

Profi-Flex is used globally by major agricultural equipment manufacturers. The component tolerances have been developed to allow all adjustable track wheels to be suitable for operations at speeds of up to 50km/h. First introduced to the market in 2009, the triple well Profi-Fit Wheel.

An evolution of the tried and tested Profi-Flex wheel is the patented – high speed version – Profi-Flex<sup>HS</sup>. A key trend within the agricultural industry in recent years has been the move towards bigger farms, meaning tractors spend

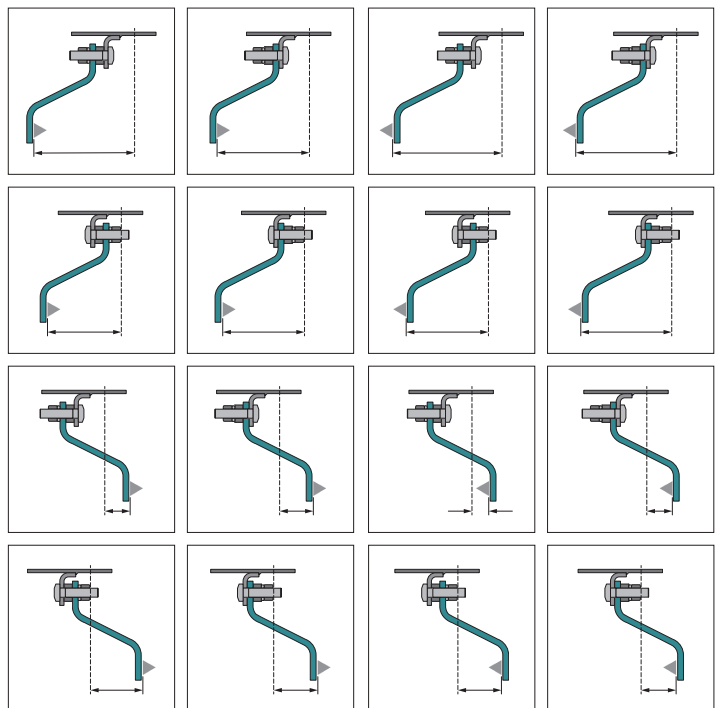

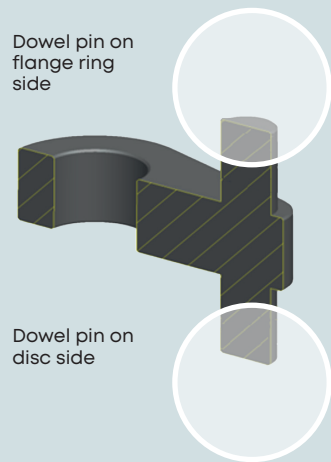
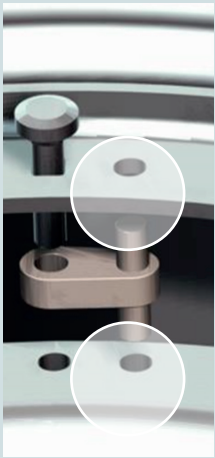
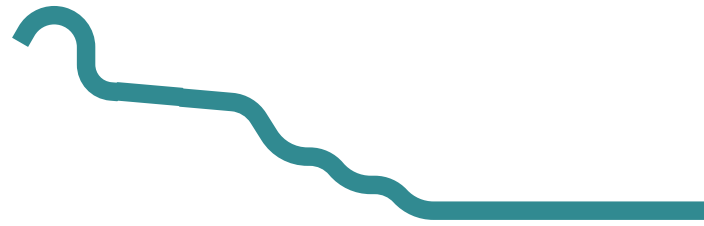

- Designed to address the issues of run-out that can occur on manually adjustable track wheels on high speed applications.
- The unique solution uses a single alignment pin which ensures that the disc has to be re-fitted in the correct position when the track spacing has been changed.
- The spacer with dowel pins is an integral part of the wheel and cannot be lost due to vibrations or left behind during the disc position change operation.
- Suitable for speeds up to 60km/h and 500 horse power.
- 16 different offsets for varying crop row widths.

more time on the road with a need to travel faster. The increasing speeds means that the issue of run-out or 'wheel wobble', becomes ever more important. The faster the tractor's speed, the more pronounced the issue becomes.

Profi-Flex<sup>HS</sup> provides a solution to address the issue of run-out that can occur on manually adjustable track wheels – Profi-Flex – wheels when used on these high speed applications. Profi-Flex<sup>HS</sup> wheel addresses this problem.

The standard for tractors that are approved for speeds of 50km/h and above requires high spot marking of the wheel and low spot marking of the tires, to ensure the tire is positioned accurately, thereby minimizing run-out and so optimizing ride comfort and performance. However to suit different operational requirements, manually-adjustable wheels enable the disc to be moved to change the track settings, and in these circumstances it is vital that when it is refitted, the disc isn't rotated and the alignment isn't altered, as this could have a significant impact on run-out.

The solution – incorporates integrated centering pins in the spacers, guaranteeing that the disc and rim are



correctly re-aligned when wheel track settings are being changed. This unique solution uses a single alignment pin which ensures that the disc has to be re-fitted in the correct position when the track spacing has been changed and the correct tolerances are maintained.

The Profi-Flex<sup>HS</sup> solution is simple and straightforward, ensuring that the manual adjustment of a tractor's track settings can be completed efficiently and accurately, every time.

The result = ride quality, comfort-levels and tractor performance are maintained at the highest levels.



# Profi-Line+

moveero

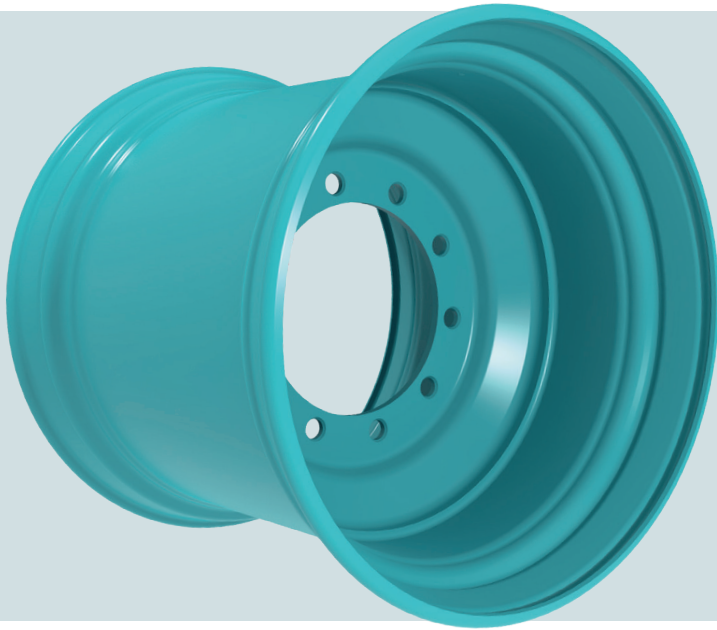
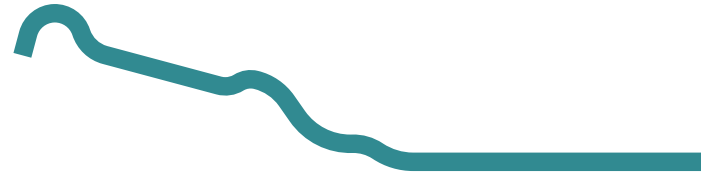

## Transporting agricultural loads with a 20% increase in load capacity

- Reduced weight with no less performance.
- Incorporates two key changes – a bent over flange radius and a double well radius.
- Five-fold increase in fatigue life.
- 40% reduction of stress in key rim areas.

Our high-performance Profi-Line+ wheels have been developed to meet the changing needs of the agricultural sector, providing increased load capacity, higher operating speeds and longer life.

Profi-Line+ provides the ideal solution for the ever increasing need for greater loads and prolonged working hours and the challenge this bring for heavy duty trailers and implements. Profi-Line+ meets the very specific requirements of heavy duty, high load-bearing flotation tires, which may be subject to sustained periods of intensive use. With a loading capacity that is 20% higher and a lifetime five-times longer than standard flotation wheels, its unique design features deliver a number of operational and performance advantages:

- The 'bent-over' flange provides improved stability and affords greater protection to the tire, both during operation and tire mounting.
- With a rim that is 10% thinner than the standard design, fuel consumption is improved.

- Wheels are available with an extra connection in the rim for CTIS (Central Tire Inflation System).
- Profi-Line+ wheels are high-spot marked, ensuring they are suitable for speeds up to 80 km/h\*.
- For the most severe and demanding applications, the option of up-grading to stronger discs is available.
- An optional valve guard may be fitted to provide even greater protection.

Profi-Line+ wheels have been developed to minimize stress on the critical radii by around 40% compared with the traditional rim shape. As a result, fatigue life is more than five times longer. The wheel's new rolled-over flange and double well radius enable it to cope with the increased pressures of heavier loads and longer periods of use. These benefits are achieved whilst reducing rim gauge and weight without any loss of performance, which means more working hours for the wheel, particularly for heavy machines with intensive usage.

\*On request, available for speeds up to 100km/h





# Profi-Hub

moveero

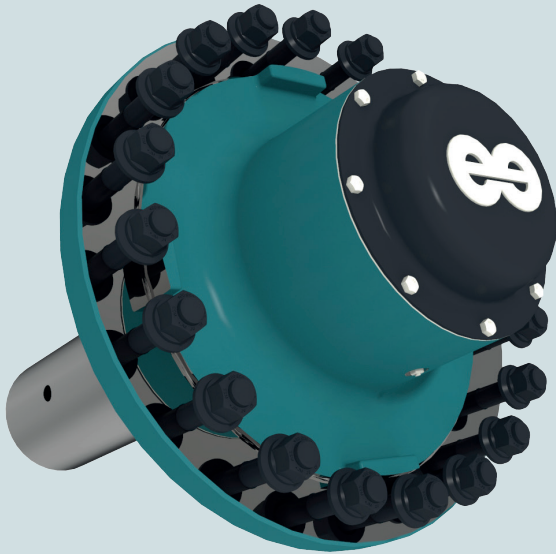

## Improved performance and easier maintenance

- A patented design solution.
- Increased carrying capacity – load requirements up to 15,700 lbs (7,100 kg) whilst casting weight is reduced by 15 lbs (6.8 kg).
- Improved bearing performance – over 2x bearing set durability with new patent pending hub shape.
- Improved servicing – recessed grease fitting reduces the risk of damage whilst in use and press-on style hub cap simplifies serviceability.
- Assemblies can be configured to customer requirements.
- Allows use of low pressure during tire inflation which increases safety.

Our Profi-Hub series has been designed to reflect the demands of modern machines, with assemblies able to be configured to meet customers' specific requirements. Profi-Hub provides increased carrying capacity (loads up to 15,700 lbs), improved bearing performance and improved servicing, with the hub's recessed grease fitting reducing the risk of damage whilst in use and its press-on style hub cap simplifying serviceability.

With a long and proud tradition manufacturing hubs and spindles, moveero is offering a solution which is a major advance in design, enabling us to continue to provide our customers with high-quality, high-performance solutions. The new range is an evolution of our proven 871 and 873 hub systems, with the re-design providing improved features, capabilities and value.

Following an extensive testing program, the Profi-Hub range has demonstrated a remarkable two and a half times bearing life improvement. A patented design, the product has been designed for a minimum of 20,000 miles (32,000km/h) service at 20 miles per hour (32 km/h). The re-design has also enabled the system's casting weight to be reduced by 15 pounds, improving the carbon footprint of each hub manufactured by 30 pounds of carbon dioxide.



# Unique selling proposition segment and brand matrix



evolving every day

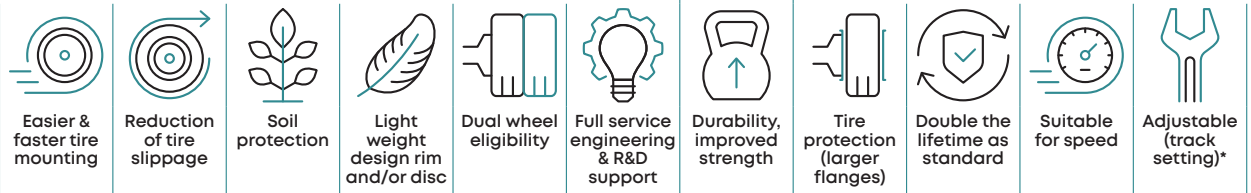

	Easier & faster tire mounting	Reduction of tire slippage	Soil protection	Light weight design rim and/or disc	Dual wheel eligibility	Full service engineering & R&D support	Higher payload	Durability, improved strength	Tire protection (larger flanges)	Double the lifetime as standard	Suitable for speed	Adjustable (track setting)*
<b>Agriculture</b>												
Tractors >250hp	Profi-Fit	Profi-Grip	-	-	Profi-Fit Profi-Grip Profi-Flex*	All product ranges	Profi-Fit Profi-Grip	Profi-Fit Profi-Grip Profi-Flex*	-	Profi-Fit Profi-Grip Profi-Flex <sup>HS</sup>	Profi-Flex*	
Standard tractors <250hp	Profi-Fit	-	-	-	Profi-Fit Profi-Flex*	All product ranges	Profi-Fit	Profi-Fit Profi-Flex*	-	Profi-Fit Profi-Grip Profi-Flex <sup>HS</sup>	Profi-Flex*	
Combines	Profi-Fit	Profi-Grip	Profi-Fit	Profi-Fit	Profi-Fit	All product ranges	Profi-Fit Profi-Grip	Profi-Fit	-	-	-	
Sprayers	Profi-Fit	Profi-Grip	Profi-Fit	Profi-Fit	-	All product ranges	Profi-Fit Profi-Grip	Profi-Fit	-	Profi-Fit Profi-Grip Profi-Flex <sup>HS</sup>	Profi-Flex*	
Implements	Profi-Line	-	Profi-Line	Profi-Line	-	All product ranges	Profi-Line	Profi-Line	-	Profi-Line*	-	
Self-propelled forage harvester	Profi-Fit	Profi-Grip	Profi-Fit	Profi-Fit	-	All product ranges	Profi-Fit Profi-Grip	Profi-Fit	-	Profi-Fit Profi-Grip Profi-Flex <sup>HS</sup>	-	
<b>Forestry</b>												
Standard single piece	-	Profi-Tuff	-	-	-	All product ranges	Profi-Tuff	Profi-Tuff	-	-	-	
<b>Construction</b>												
Single piece light construction (skidsteer loaders, telehandlers, backhoe-loaders, compact wheel loaders)	Infini-Fit	-	-	-	-	All product ranges	Profi-Fit	-	-	-	-	
Multi Piece heavy construction (articulated dump-trucks, wheel loaders, motor-graders, road pavers)	-	-	-	-	-	All product ranges	-	-	-	-	-	
<b>Material Handling</b>												
Multi piece container handling & stackers	-	-	-	-	Standard Multi-piece Infini-Forge	All product ranges	Infini-Forge	Standard Multi-piece Infini-Forge	Infini-Forge	-	-	
Multi piece mobile cranes	-	-	-	-	-	All product ranges	-	-	-	-	-	
Fork lift truck	-	-	-	-	-	All product ranges	-	-	-	-	-	
<b>Mining</b>												
Underground <=33 inch	-	-	-	-	-	All product ranges	Infini-Forge	-	Infini-Forge	-	-	

\* Profi-Flex available as Profi-FlexHS with unique spacer to address issue of run out and suitable for speeds up to 50km/h







**moveero Headquarters**

moveero Inc  
PO Box 48, 5453 6th Avenue  
Armstrong, Iowa 50514  
USA

**[www.moveero.com](http://www.moveero.com)**

**moveero UK**

Hadley Castle Works  
Telford, Shropshire TF1 6AF  
United Kingdom

**moveero Denmark**

Nagbølvej 31  
DK – 6640, Lunderskov  
Denmark

**moveero USA**

PO Box 48, 5453 6th Avenue  
Armstrong, Iowa 50514  
USA

**moveero USA**

Test & Validation Center  
2420 7th Ave S, Estherville, Iowa 51334-2786  
USA

**moveero Italy**

moveero Global Innovation and R&D Center  
Via Molino Emili 18, 25030 Maclodio (BS)  
Italy